



AG1200

Usage Instructions

1200W Angle Grinder



Read before use



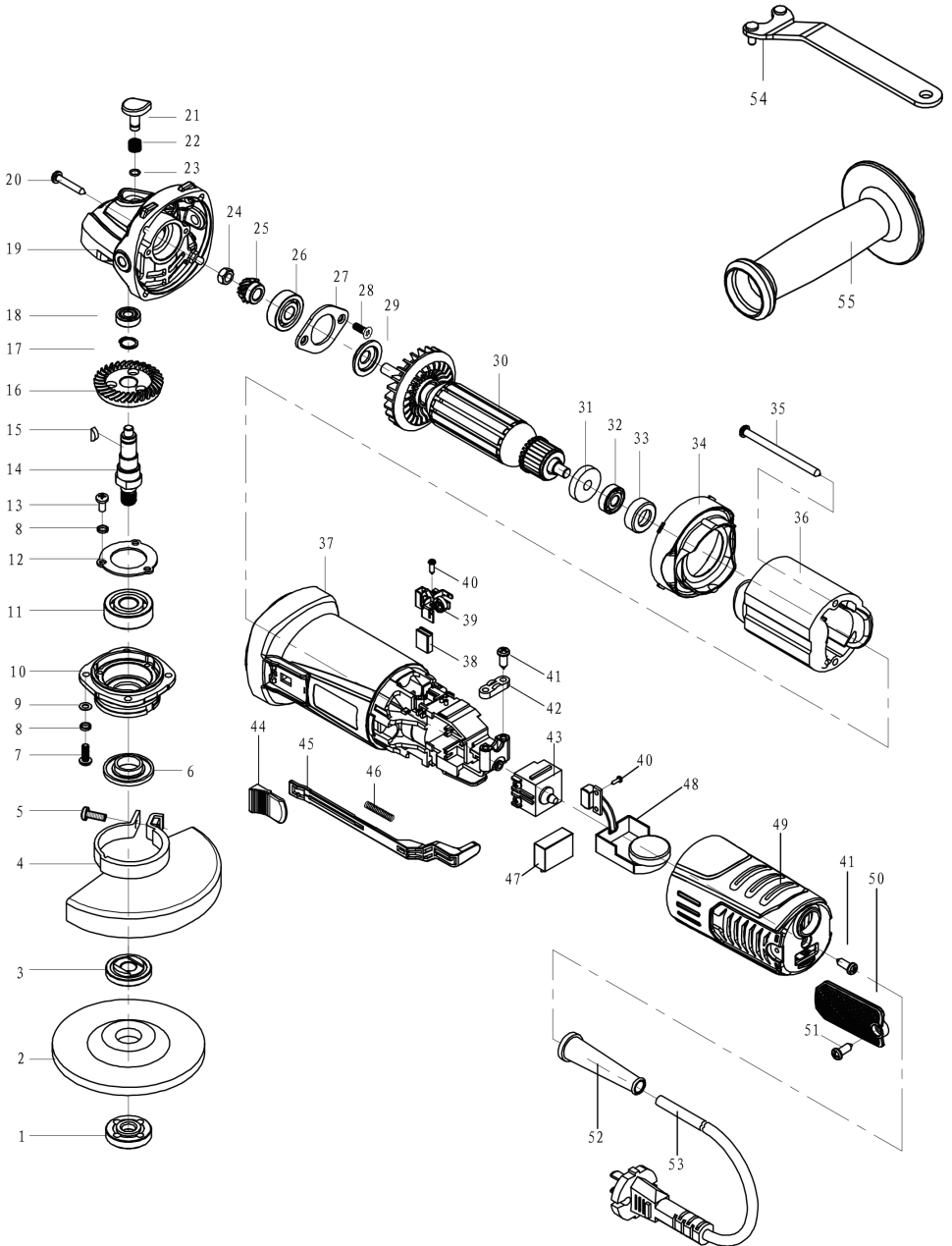

Spare Part List











1	outer flange	29	dust washer
2	grinding disc excluded	30	armature
3	inner flange	31	magnet ring
4	grinding wheel guard	32	bearing 607-2rst
5	screw M6x18	33	bearing sleeve
6	dust cover	34	wind baffle
7	screw M4x14	35	screw
8	spring washer 4	36	stator
9	flat washer 4	37	motor housing
10	front cover	38	carbon brush (set)
11	bearing 6201-2RST	39	brush holder (set)
12	bearing plate	40	screw
13	screw M4X10	41	screw ST4.2X 14
14	output shaft	42	cable plate
15	key 2.5x3.7x Ø10	43	switch
16	big gear	44	switch push
17	circlip 11	45	switch push rod
18	bearing-2Z	46	spring of push rod
19	gear box	47	capacitance (0.33uf)
20	screw ST4 2X27	48	constant power of speed controller
21	lock pin	49	rear cover
22	lock spring	50	net plate (set)
23	circlip 6	51	screw
24	hex nut M6	52	cable shield
25	pinion	53	cable
26	bearing 608-2RT	54	spanner
27	bearing clamp	55	side handle
28	screw M4X12		

INDEX

- 1 Safety Warnings
- 2 Application
- 3 Using Instructions
- 4 Cleaning and Maintenance
- 5 Accessories
- 6 Environmental Protection
- 7 Warranty
- 8 Attachments

Symbols

The following are the icons that are used for the tool. Make sure you fully understand them before using them.

	Read the instruction manual		Class II machine
	CE mark		Wear safety gloves
	Caution		Wear hearing protectors
	Conforms to WEEE		Wear safety glasses
	Class II machine		Warning risk of cutting by the saw
			Use of segmented blades prohibited

1. Safety Warnings

⚠ Caution

Read all safety instructions and warnings provided with power tool. Failure to follow the instructions below may result in electric shock, fire and / or serious injury.

Keep all warnings and instructions for future reference.

The term "power tool" used in the safety instructions refers to mains operated power tools (with power cord) or to battery operated tools (without power cord).

General safety warnings for power tools

1.1 Safety in work area

- a) **Keep your work area clean and well lit.** Disarray or unlit work areas can lead to accidents.
- b) **Do not work with the power tool in a potentially explosive environment in which flammable liquids, gases or dusts are present.** Power tools generate sparks that can ignite the dust or fumes.
- c) **Keep children and bystanders away while using the power tool.** Distractions can result in a loss of control.

1.2 Electrical Safety

- a) **The plug of the power tool must fit into the socket. The plug must not be changed in any way.** Do not use adapter plugs together with electrically grounded power tools. Unmodified plugs and matching sockets reduce the risk of electric shock.
- b) **Avoid body contact with grounded surfaces such as pipes, heaters, stoves, and refrigerators.** There is an increased risk of electric shock if your body is grounded.
- c) **Keep power tools away from rain or moisture.** The penetration of water into a power tool increases the risk of electric shock.
- d) **Do not misuse the power cord to carry the power tool, hang it up, or unplug it from the power outlet.** Keep the connection cable away from heat, oil, sharp edges or moving parts. Damaged or entangled leads increase the risk of electric shock.
- e) **When working outdoors with a power tool, only use extension cables that are also suitable for outdoor use.** Using an extension cord suitable for outdoor use reduces the risk of electric shock.
- f) **If operation of the power tool in a damp environment is unavoidable, use a residual current device.** Using a residual current circuit breaker reduces the risk of electric shock.

1.3 Personal Safety

- a) **Be attentive, pay attention to what you are doing and be reasonable about working with a power tool. Do not use a power tool when you are tired or under the influence of drugs, alcohol or medication.** A moment of carelessness when using the power tool can cause serious injury.
- b) **Wear personal protective equipment and always safety goggles.** Wearing personal protective equipment such as a dust mask, non-slip safety shoes, hard hat or ear protection, depending on the type and use of the power tool, reduces the risk of personal injury.

- c) **Avoid unintentional startup. Make sure that the power tool is switched off before connecting, receiving or carrying it to the power supply and / or the battery.** Keeping your finger on the switch when you are wearing the power tool or plugging the power tool into power can cause an accident.
- d) **Remove setting tools or wrenches before turning on the power tool.** A tool or key located in a rotating part of the power tool can cause injury.
- e) **Avoid an abnormal posture. Ensure a secure footing and maintain balance at all times.** This allows you to better control the power tool in unexpected situations.
- f) **Wear suitable clothing. Do not wear loose clothing or jewelry.** Keep hair and clothing away from moving parts. Loose clothing, jewelry or long hair can be caught by moving parts.
- g) **If dust extraction and collection equipment can be installed, they must be connected and used properly.** Using a dust extractor can reduce dust hazards.
- h) **Do not weigh yourself in false safety and do not overstep the safety rules for power tools, even if you are familiar with the power tool after many uses.** Careless action can lead to serious injuries within fractions of a second.

1.4 Use and care of the power tool

- a) **Do not overload the power tool. Use the appropriate power tool for your work.** With the right power tool you work better and safer in the specified power range.
- b) **Do not use a power tool whose switch is defective.** A power tool that can not be turned on or off is dangerous and must be repaired.
- c) **Unplug the power cord and / or remove a detachable battery before making any adjustments to the device, changing the tool bits, or putting the power tool away.** This precaution prevents the unintentional start of the power tool.
- d) **Store unused power tools out of the reach of children. Do not allow persons to use the power tool that are unfamiliar or have not read these instructions.** Power tools are dangerous when used by inexperienced people.
- e) **Maintain power tools and insert tools with care. Check that moving parts are working properly and do not jam, that parts are broken or damaged enough to impair the functioning of the power tool. Have damaged parts repaired before using the power tool.** Many accidents are caused by badly maintained power tools.
- f) **Keep cutting tools sharp and clean.** Carefully maintained cutting tools with sharp cutting edges become less jammed and easier to guide.
- g) **Use power tools, accessories, tools etc. according to these instructions. Take into account the working conditions and the activity to be performed.** The use of power tools for other than intended applications can lead to dangerous situations.
- h) **Keep handles and grips dry, clean and free of oil and grease.** Slippery handles and gripping surfaces do not allow safe operation and control of the power tool in unforeseen situations.

1.5 Use and care of the battery tool

- a) **Charge the batteries only with chargers recommended by the manufacturer.** A charger suitable for a particular type of battery may cause a fire when used with other batteries.
- b) **Use only the appropriate batteries in the power tools.** Use of other batteries may cause injury or fire.
- c) **Keep the unused battery away from paper clips, coins, keys, nails, screws, or other small metal objects that could cause the contacts to bridge.** A short circuit between the battery contacts can cause burns or fire.
- d) **If used incorrectly, liquid may leak from the battery. Avoid contact with it. In case of accidental contact, rinse with water. If the fluid gets into your eyes, seek additional medical attention.** Leaking battery fluid may cause skin irritation or burns.
- e) **Do not use a damaged or modified battery.** Damaged or altered batteries can behave unpredictably and cause fire, explosion or injury.
- f) **Do not expose a battery to fire or high temperatures.** Fire or temperatures over 130 ° C can cause an explosion.
- g) **Follow all charging instructions and never charge the battery or the cordless tool outside the temperature range specified in the operating instructions.** Incorrect charging or charging outside the permitted temperature range can destroy the battery and increase the risk of fire.

1.6 Service

- a) **Only have your power tool repaired by qualified personnel and only with original spare parts.** This ensures that the safety of the power tool is maintained.
- b) **Never use damaged batteries.** All battery maintenance should only be done by the manufacturer or authorized service centers. Follow the instructions for lubricating and changing accessories.

Additional safety warning from the manufacturer

DO NOT let comfort or familiarity with product (gained from repeated use) replace strict adherence to grinder safety rules. **If you use this tool unsafely or incorrectly, you can suffer serious personal injury.**

- **Always use proper guard with grinding wheel.** A guard protects operator from broken wheel fragments.
- **Accessories must be rated for at least the speed recommended on the tool warning label.**
Wheels and other accessories running over rated speed can fly apart and cause injury.
- **Hold tool by insulated gripping surfaces when performing and operation where the cutting tool may contact hidden wiring or its own cord.**
Contact with a "live" wire will make exposed metal parts of the tool "live" and shock the operator.
- **When using depressed center grinding wheels, be sure to use only fiberglass reinforced wheels.**
- **Always use safety glasses or goggles. Ordinary eye or sun glasses are NOT safety glasses.**
- **Check the wheel carefully for cracks or damaged before operation.** Replace cracked or damaged wheel immediately.
Run the tool (with guard) at no load for about a minute, holding too away from others. If wheel is flawed, it will likely separate during this test.
- **Use only flanges specified for this tool.**
- **Be careful not to damage the spindle, the flange (especially the installing surface) or the out flange.**
Damage to these parts could result in wheel breakage.
- **NEVER use tool with wood cutting blades or other saw blades.** Such blades when used on a grinder frequently kick and cause loss of control leading to personal injury.
- **Hold the tool firmly.**
- **Keep hands away from rotating parts.**
- **Make sure cord is clean of wheel.** Do not wrap cord around your arm or wrist. If control of tool is lost, cord may become wrapped around you and cause personal injury
- **Make sure the wheel is not contacting the workpiece before the switch is turned on.**
- **Before using the tool on an actual workpiece let it run for a while.** Watch for vibration or wobbling that could indicate poor installation or a poorly balanced wheel.
- **Use the specified surface of the wheel to perform the grinding.**
- **Watch out for flying sparks.** Hold the tool so that sparks fly away from you and other persons on flammable materials.
- **Do not leave the tool running.** Operate the tool only when hand-held.
- **Do not touch the workpiece Immediately after operation; it may be extremely hot and could burn your skin.**
- **ALWAYS wear proper apparel including long sleeve shirts. Leather gloves and shop aprons to protect skin from contact with not grindings.**
- **Use of this tool to grind or sand some products Paints and wood could expose user to dust containing hazardous substances. Use appropriate respiratory protection.**

2. Application

- Soft start and constant speed
- 6 gears from 3,000-11,000 RPM
- M14 connection with TPR handle
- Suitable for drilling holes, cutting tiles and polishing jobs.

Model	AG1200
Voltage/Frequency	230V/50Hz
Input Power	1200W
No Load speed	11000/min
Accessories	1pc Side handle, 1pc Spanner, 1set Carbon brush, 1pc Wheel guard

Manufacturer reserves the right to change specifications without notice. Specifications may differ from country to country

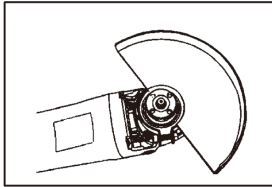

Fig1

3. Using Instructions

3.1 Wheel guard

Please aim the convex end of the wheel guard to the slot mouth of the front cover, and then rotate the guard body to 180 degree, finally tighten the fastening screw. (Fig1 & Fig2)

⚠ Caution

3.2 Installing or removing grinding wheel

When using an abrasive cut-off wheel, be sure to use only the supplied wheel guard, inner flange, out flange designed for use with cut-off wheels.

- Mount the inner flange onto the spindle, Fit the wheel/disc on the inner flange and screw the outer flange onto the spindle (Fig 3).
- To tighten the outer flange, Press the shaft lock firmly so that the spindle cannot revolve, then use the spanner (shown in Fig3) and securely tighten clockwise. (Fig4)
- To remove the wheel, follow the installation procedure in reverse.

NOTICE:

The groove of INNER FLANGE must align the flatness of spindle when you install the wheel and tighten enough.

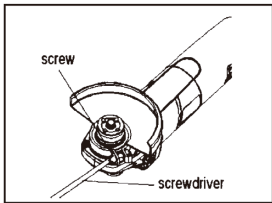

Fig2

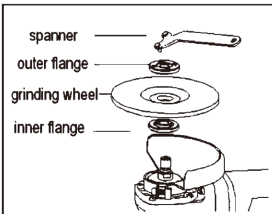

Fig3

⚠ Caution

3.3 Side handle

- Always be sure that the side handle is installed securely before operation.
- The both sides & top side of tool's head designed three screw holes to assemble the grip side.
- Screw the side handle securely on the position of the tool as shown in the figure 5.
- Hold the side handle firmly by hand all the way you will control the tool better.

⚠ Caution

3.4 Switch action

- Before plugging in the tool, always check to see that the switch trigger actuates properly and returns to the backward position when released.
- Switch can be locked in the forward position for ease of operator comfort during extended use.
- Apply caution when locking tool in continually running position and maintain firm grasp on tool.
- To start the tool, push the switch button forward, and will be locked into continually running after pushed totally. To stop the tool, just press the rear end of switch button, and it will automatically goes back totally.
- Put the tool down after it stops fully.

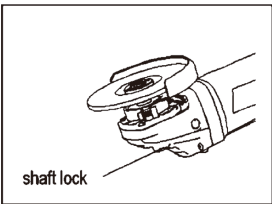

Fig4

3.5 Effective and safe for grinding and sanding operation.

Always hold the tool firmly with one hand on housing and the other on the side handle, turn the tool on and them apply the wheel or disc to the workpiece.

- Forbid operating the tool under the condition of removing the wheel guard.
- The users can get satisfied effects if the users give 1/2 strength compared with the own weight of the tool. Over strength is easy to make the tool engine and abrasive wheel damaged because of overload.
- Generally speaking, please keep the grinding and cutting part of the wheel and disc in the scope of 15 to 30 degree with the surface of processing object.(Fig 5)
- In general operation, should start first then work, In reverse should leave workpiece then stop.

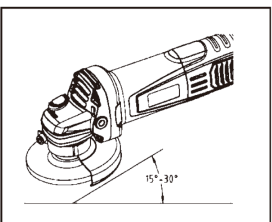

Fig5

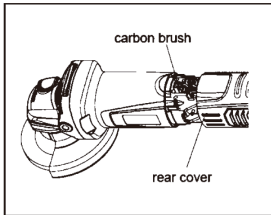

Fig6

3.6 Replacing carbon brushes.

1. Remove and check the carbon brushes regularly. Replace when the tool occur obvious sparks or wear down to 4-6mm left.
2. Both carbon brushes should be replaced at the same time. Use only brushes provided. Pull down the rear cover after the screw in the rear cover was loosen by a screwdriver, then replace the brush (Fig6).
3. Please send this tool to the authorized service center to replace or be replaced by the experienced worker always.

⚠ Caution

After replacing brushes, plug in the tool and break in brushes by running tool with no load for about 10 minutes. Then check the tool while running, when releasing the switch trigger. If the tool is not working well, ask your local service center for repair.

To maintain product SAFETY and RELIABILITY repairs, any other maintenance or adjustment should be performed by Authorized or factory service centers, always using factory replacement parts.

4. Cleaning and Maintenance

⚠ Caution

Always be sure that the tool is switch off and unplugging before attempting to perform inspection and maintenance.

- The tool and its air vents have to be keep clean, regularly clean the tool's air vents or whenever the vents start to become obstructed.
- Check the all screws if be loosened or no periodically.
- Usually check the cord insulation if broken or not.

5. Accessories

- This accessory is recommended for use with your device specified in this manual.
- Using other accessories or attachments may result in personal injury. Only use accessories or accessories for the stated purpose.

6. Environmental Protection

- Do not dispose of electrical appliances in the household waste.
- Follow the local provisions for the disposal of electrical or battery products.
- Valuable materials can be recovered by recycling.
- The electrical or battery components used for construction are in accordance with the regulation European Directive 2012/19 / EU on waste electrical and electronic equipment and transposition into national law., used electrical appliances must be collected separately and recycled in an environmentally sound manner.
- Contact us for further information.



7. Warranty

- The guarantee covers all manufacturing or assembly defects in accordance with the legislation in force. The guarantee does not cover malfunctions caused by improper use, overloads, failure to follow the operating instructions and normal wear and tear.
- For more details and information, consult the general guarantee conditions at www.bihuitools.com

8. Attachments

CE Declaration of Conformity